



WATER RESOURCES AUTHORITY
Accounting for Every Drop!

ADDENDUM

TENDER NO; WRA/T/4/2018-2019

PROCUREMENT FOR CONSTRUCTION, SUPPLY, INSTALLATION, TRAINING, BRANDING AND COMMISSIONING OF TEN (10) MULTI- PARAMETER TELEMETRIC STATIONS

We would like to correct appendices in the Terms of references which was erroneously left out.

APPENDICES

1. Concrete Post design

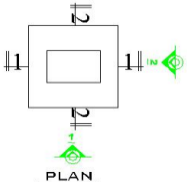
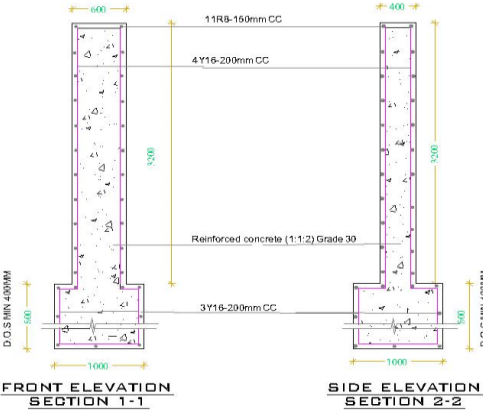
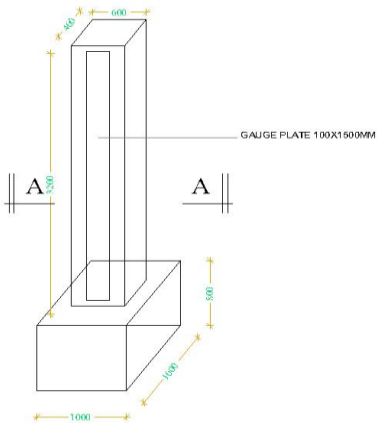

2. Logger House plan

HOUSE PLAN

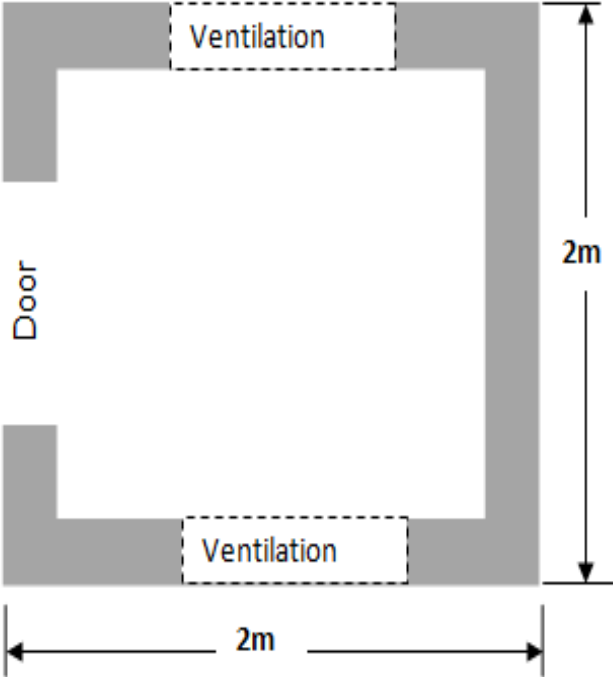

ROOF SLAB PLAN

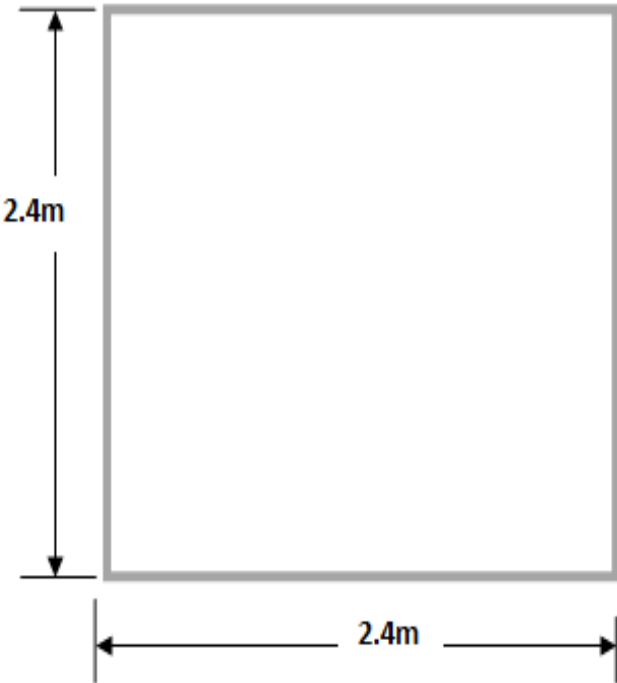

3. Logger House Design

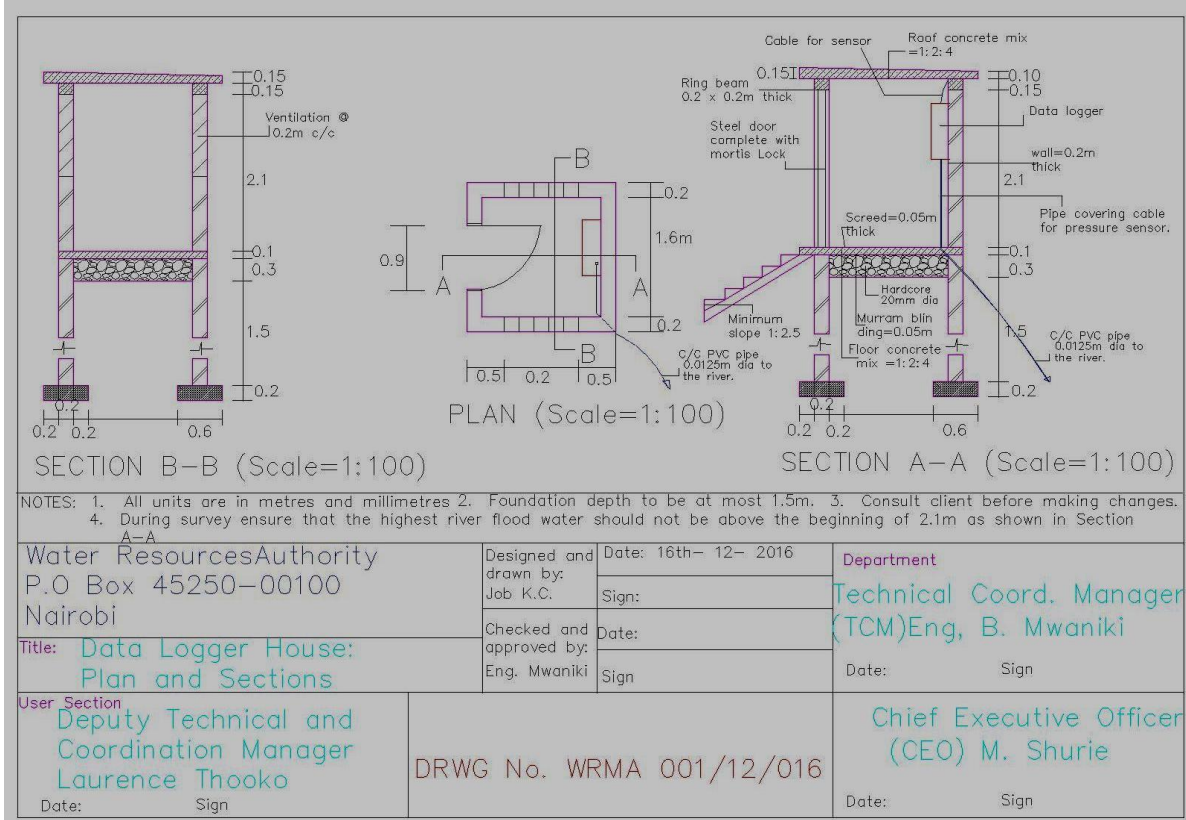

4. Sketch for Reinforced concrete post Signboard

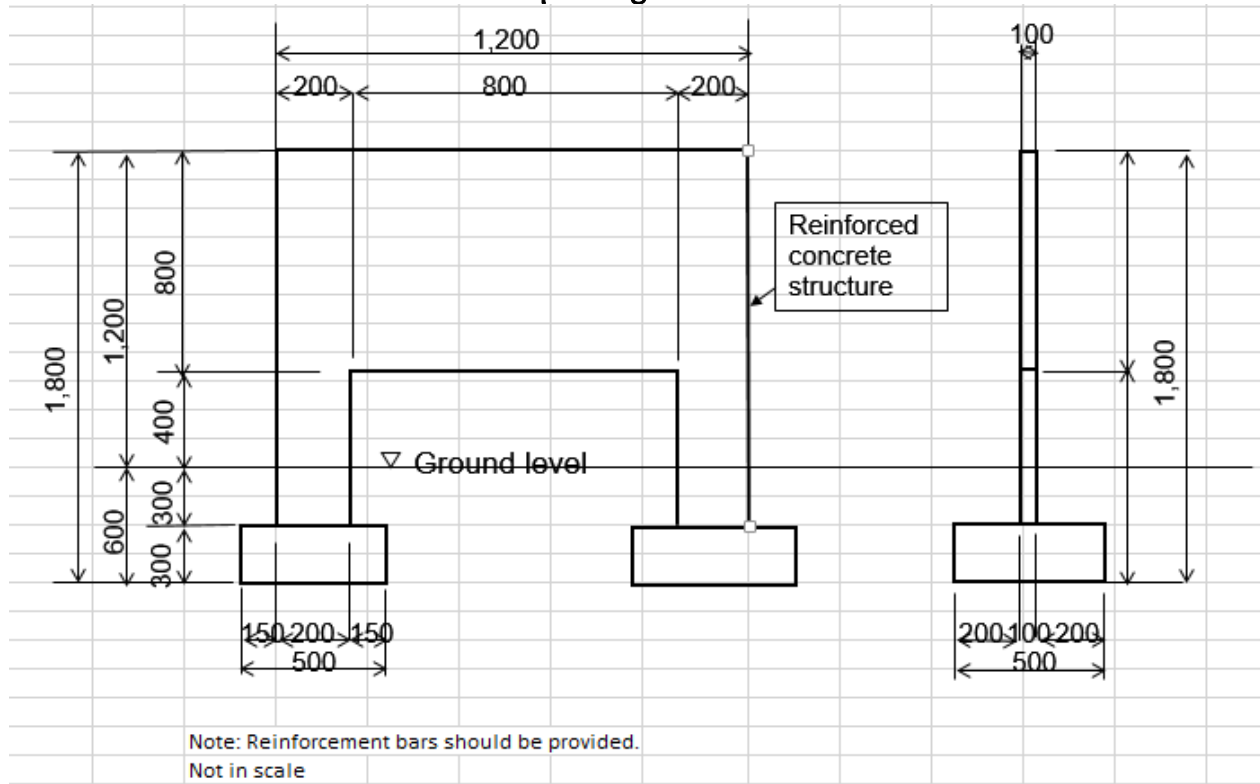

5. Fence Sketch

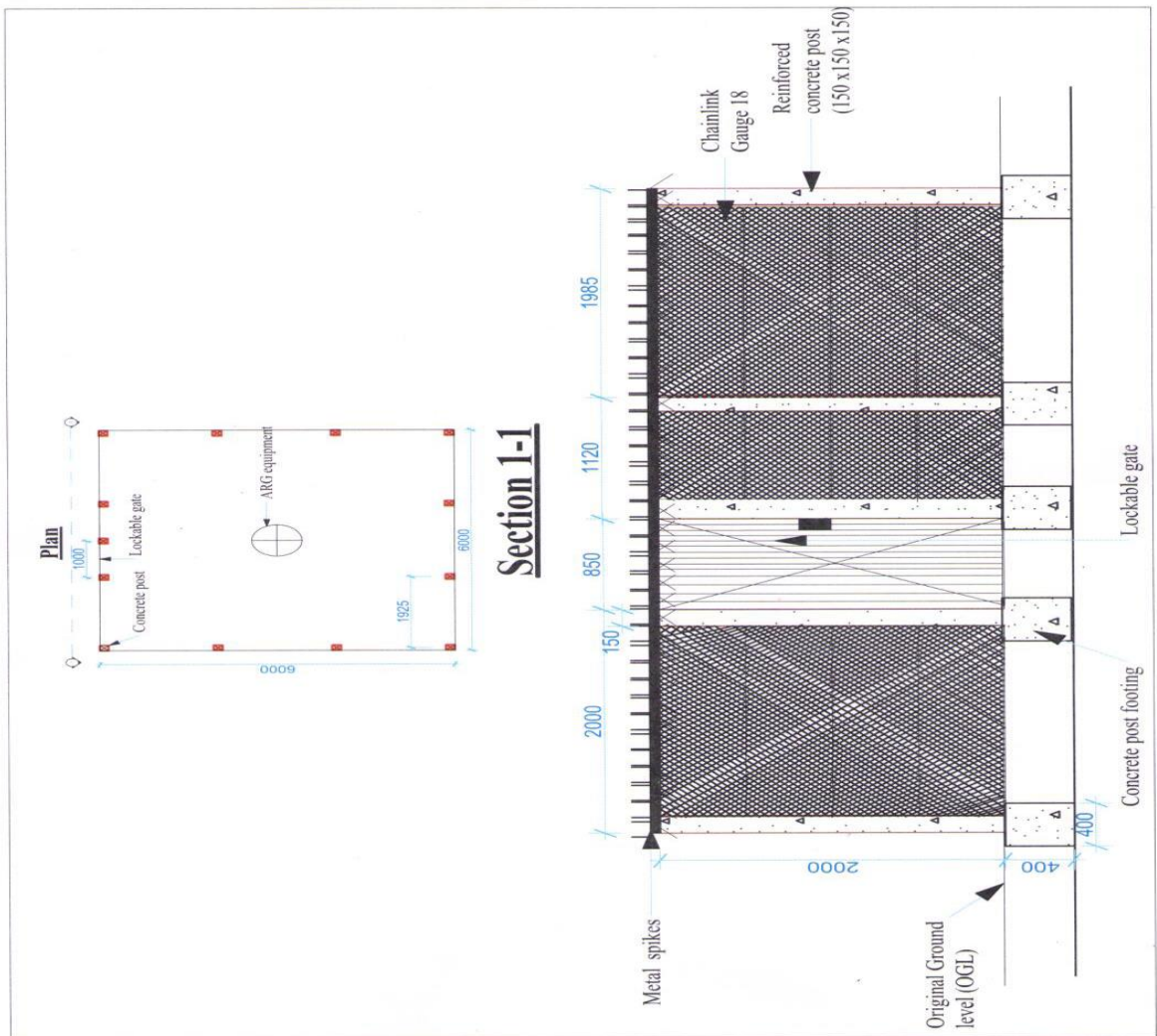

The Closing date will be **25th February, 2019 at 11.00am.**

**Chief Supply Chain Management Officer
Water Resources Authority
P. O Box 45250-00100
NAIROBI**